

# TOSHIBA

Leading Innovation >>>

## TDP-XP1

# DATA PROJECTOR

## OWNER'S MANUAL

---



In the spaces provided below, record the Model and Serial No. located at the bottom of your projector.

Model No. \_\_\_\_\_ Serial No. \_\_\_\_\_

Retain this information for future reference.

Before Using

Preparations

Operations

Maintenance

Others

# SAFETY PRECAUTIONS

---



The lightning flash with arrowhead symbol, within an equilateral triangle, is intended to alert the user to the presence of uninsulated “dangerous voltage” within the product’s enclosure that may be of sufficient magnitude to constitute a risk of electric shock to persons.



The exclamation point within an equilateral triangle is intended to alert the user to the presence of important operating and maintenance (servicing) instructions in the literature accompanying the appliance.

**WARNING:** TO REDUCE THE RISK OF FIRE OR ELECTRIC SHOCK, DO NOT EXPOSE THIS APPLIANCE TO RAIN OR MOISTURE. DANGEROUS HIGH VOLTAGES ARE PRESENT INSIDE THE ENCLOSURE. DO NOT OPEN THE CABINET. REFER SERVICING TO QUALIFIED PERSONNEL ONLY.

**WARNING:** Handling the cord on this product or cords associated with accessories sold with this product, will expose you to lead, a chemical known to the State of California to cause birth defects or other reproductive harm. ***Wash hands after handling.***

**USA only**

**USA only**

Lamp contains mercury. Disposal of this product may be regulated due to environmental considerations. For disposal, reuse or recycling information, please contact your local government or the Electronic Industries Alliance at [www.eiae.org](http://www.eiae.org).

**MODEL NAME: TDP-XP1** **USA only**

TRADE NAME: DATA PROJECTOR

MODEL NAME: TDP-XP1



Tested To Comply  
With FCC Standards

FOR HOME OR OFFICE USE

**FCC NOTICE:** This device complies with part 15 of the FCC Rules. Operation is subject to the following two conditions:

(1) This device may not cause harmful interference, and (2) this device must accept any interference received, including interference that may cause undesired operation. This equipment has been tested and found to comply with the limits for a Class B digital device, pursuant to part 15 of the FCC Rules. These limits are designed to provide reasonable protection against harmful interference in a residential installation. This equipment generates, uses and can radiate radio frequency energy and, if not installed and used in accordance with the instructions, may cause harmful interference to radio communications. However, there is no guarantee that interference will not occur in a particular installation. If this equipment does cause harmful interference to radio or television reception, which can be determined by turning the equipment off and on, the user is encouraged to try to correct the interference by one or more of the following measures:

- 
- Reorient or relocate the receiving antenna.
  - Increase the separation between the equipment and receiver.
  - Connect the equipment into an outlet on a circuit different from that to which the receiver is connected.
  - Consult the dealer or an experienced radio/TV technician for help.

RESPONSIBLE PARTY: TOSHIBA AMERICA INFORMATION SYSTEMS, INC.

9740 Irvine Blvd., Irvine, CA 92618-1697 U.S.A

Phone: (949) 583-3000

**CAUTION:** Changes or modifications made to this equipment, not expressly approved by **USA only** Toshiba, or parties authorized by Toshiba, could void the user's authority to operate the equipment.

**NOTICE:** This Class B digital apparatus complies with Canadian ICES-003. Cet appareil numérique de la classe B est conforme à la norme NMB-003 du Canada. **CANADA only**

# IMPORTANT SAFETY INSTRUCTIONS

---

**CAUTION: PLEASE READ AND OBSERVE ALL WARNINGS AND INSTRUCTIONS GIVEN IN THIS OWNER'S MANUAL AND THOSE MARKED ON THE UNIT. RETAIN THIS BOOKLET FOR FUTURE REFERENCE.**

This unit is fully transistorized and does not contain any parts that can be repaired by the user.

**WARNING: DO NOT REMOVE THE CABINET COVER, OR YOU MAY BE EXPOSED TO DANGEROUS VOLTAGE. REFER SERVICING TO QUALIFIED SERVICE PERSONNEL ONLY.**

## 1. Read Owner's Manual

After unpacking this product, read the owner's manual carefully, and follow all of the operating and other instructions.

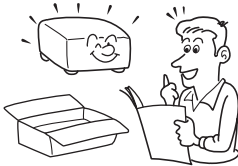

## 2. Power Sources

This product should be operated only from the type of power source which does not exceed the voltage range specified on the rating label and the power cord. If you are not sure of the type of power supply to your home, consult your product dealer or local power company.



## 3. Source of Light

Do not look into the lens while the lamp is on. The strong light from the lamp may cause damage to your eyesight.

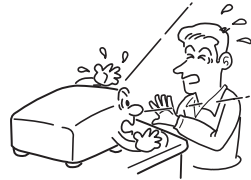

## 4. Ventilation

Openings in the cabinet are provided for ventilation and to ensure reliable operation of the product and protect it from overheating. These openings must not be blocked or covered. Never block an opening by placing the product on a bed, sofa, rug or other similar surface. Do not place it in a built-in installation such as a bookcase or rack, unless proper ventilation is provided.



**5. Heat**

The product should be situated away from heat sources such as radiators, heat registers, stoves, or other products (including amplifiers) that produce heat.

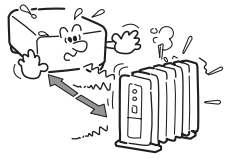

**6. Water and Moisture**

Do not use this product near water. - for example, near a bath tub, wash bowl, kitchen sink, or laundry tub; in a wet basement; or near a swimming pool and the like.



**7. Cleaning**

Unplug this product from the wall outlet before cleaning. Do not use liquid cleaners or aerosol cleaners. Always use a soft cloth for cleaning.

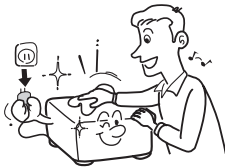

**8. Be sure that you firmly insert the plug into the wall outlet.**

Incorrect or faulty connections may result in fire or electric shock. Avoid using an unsound or loose outlet.

**9. Power Cord Protection**

Power cords should be routed so that they are not likely to be walked on or pinched by items placed upon or against them, paying particular attention to cords at plugs, convenience receptacles, and the point where they exit from the product.



**10. Overloading**

Do not overload wall outlets. To reduce the risk of electric shock, do not use the polarized plug with an extension cord, receptacle, or other outlet unless the blades can be inserted completely with three-wire grounding type to prevent blade exposure. Failure to follow these instructions may result in fire or electric shock.

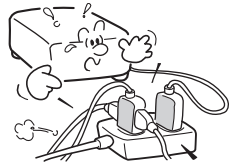

# IMPORTANT SAFETY INSTRUCTIONS (Continued)

---

## 11. Lightning storms

For added protection for this product during a storm, or when it is left unattended and unused for long periods of time, unplug it from the wall outlet. This will prevent damage to the product due to lightning and power-line surges. Never operate this unit on AC power during a thunderstorm. If you see lightning or hear thunder, never touch the unit, cables and/or peripherals. An electric surge caused by the storm, may result in an electrical shock or damage to the unit.

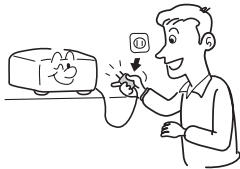

## 12. Object and Liquid Entry

Never push objects of any kind into this product through openings as they may touch dangerous voltage points or short-out parts that could result in a fire or electric shock. Never spill liquid of any kind on the product.



## 13. Do not place or keep the projector within the reach of the children.

It may fall or tip over, possibly causing serious injury.

## 14. Do not place the product vertically

Do not use the product in the upright position or any other vertical positions to project the pictures. It may fall which could result in serious injury and/or damage to the product.

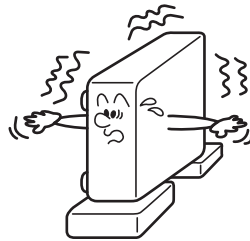

## 15. Stack Inhibited

Do not stack other equipment on this product and do not place this product on other equipment. The top and bottom surface of this product increase in temperature during normal use and may damage the other unit.



## 16. Attachments

Do not use attachments not recommended by the product manufacturer. Use of an incompatible attachments could cause hazards or damage to the product.

## 17. Accessories

Do not place this product on an unstable cart, stand, tripod, bracket, or table. The product may fall, causing serious injury to a child or adult, and serious damage to the product. A product and cart combination should be moved with care. Quick stops, excessive force, and uneven surfaces may cause the product and cart combination to overturn.



S3125A

## 18. Damage Requiring Service

Unplug this product from the wall outlet and take the product to qualified service personnel if you encounter any of the following conditions:

- a) The power supply cord or plug is damaged.
- b) Liquid has been spilled, or objects have fallen into the product.
- c) The product has been exposed to rain or water.
- d) The product does not operate normally when following the operating instructions. Adjust only those controls that are covered by the operating instructions since an improper adjustment of other controls may result in damage and will often require extensive work by a qualified technician to restore the product to its normal operation.

- e) The product has been dropped or damaged in any way (If the cabinet should break, please handle with care to avoid injury).
- f) The product exhibits a distinct change in performance, which indicates a need for service.

## 19. If glass components, including lens and lamp, should break, contact your dealer for repair service.

This product incorporates glass components, including a lens and a lamp. If these should break, please handle with care to avoid injury and contact your dealer for repair service. Avoid any broken pieces of glass since they may cause injury. In the unlikely event that the lamp ruptures, thoroughly clean the area around the projector and discard any edible items placed in that area since they may be contaminated.

## 20. Servicing

Do not attempt to service this product yourself as opening or removing covers may expose you to dangerous voltage or other hazards. Refer all servicing to qualified service personnel.

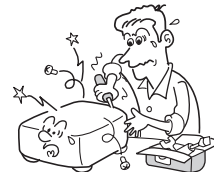

# IMPORTANT SAFETY INSTRUCTIONS (Continued)

---

## 21. Replacement Parts

When replacement parts are required, be sure the service technician has used replacement parts specified by the manufacturer or have the same characteristics as the original part.

Unauthorized substitutions may result in fire, electric shock, or other hazards.

(Only the replacement of the lamp should be made by users.)

## 22. Safety Check

Upon completion of any service or repairs to this product, ask the service technician to perform safety checks to verify that the product is in proper operating condition.



## 23. Do not leave thermal-paper documents or easily deformed items on top of the unit or near the air exhaust for long periods of time.

The heat from the unit could erase the information on the thermal paper, or cause deformation or warping.

## 24. Do not use the product in a closed installation location.

Do not place the product in a box or in any other closed installation location. Otherwise it may overheat, which could result in a risk of fire.



# POWER SUPPLY INFORMATION

If your line voltage is 220 to 240V, use one of the following types of cable/plug.

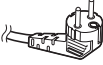
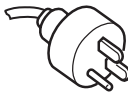
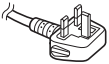
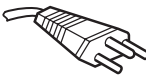
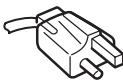
Plug configuration	Plug type	Line voltage	Plug configuration	Plug type	Line voltage
	EURO	220 – 240V		Australian 240V 10A	200 – 240V
	UK	220 – 240V		Switzerland 240V 6A	200 – 240V
				North American 240V 15A	200 – 240V

Use a 5A fuse which is approved by ASTA or BSI to BSI362.  
Always replace the fuse cover after changing the fuse.

## IMPORTANT PRECAUTIONS

### Moisture Condensation

Never operate this unit immediately after moving it from a cold location to a warm location. When the unit is exposed to such a change in temperature, moisture may condense on the lens and the crucial internal parts. Do not use the unit for at least 2 hours when there is an extreme or sudden change in temperature to prevent the unit from possible damage.

### Place and Manner of Installation

- Do not place in hot locations, such as near heating equipment. Doing so could cause malfunction, and shorten the life of the projector.
- Avoid locations with oil or cigarette smoke. Doing so will dirty the optical parts, shortening their lives, and darkening the screen.
- Do not use this product in the upright position or tilt it up or down by more than 20° from level. Doing so may cause a failure or shorten the life of the product.
- Using this instrument near a TV or radio may cause interference to the images or audio sound. If this happens, move it away from the TV or radio.
- Moving the projector from a low-temperature room to a high-temperature room may cause condensation on the lens or internal parts. If you continue to use it in that situation it may malfunction. Wait until the condensation naturally disappears.
- In a high altitude location where air is thin, cooling efficiency is reduced so use the projector with **[Fan mode]** set to **[High]**. [p.34](#)

## IMPORTANT PRECAUTIONS (Continued)

---

- The set of projector is hot after use. Handle with care.
- Do not use the projector while holding it in your hands or lap.
- Do not use the projector near a power source and the like, or in locations like a ship or vehicle that are subject to vibration or shock. Doing so may lead to a malfunction or shorten service life.
- Only plug the power cord into outlets rated for use with the power cord's specified voltage range. Do not overload extension cords or power strips as this can result in fire or electric shock.
- Route the power cable or the connecting cable away from where people could trip over it. The projector may fall, which could result in severe injury.
- Be sure the power cord is easily reached for unplugging in case of emergency. Do not place any obstacles near a wall outlet in which the cord is plugged.

### Avoid Volatile Liquid

Do not use volatile liquids, such as an insect spray, near the unit. Do not leave rubber or plastic products touching the unit for a long time, as they will leave marks on the finish. Do not use a chemically saturated cloth.

## EXEMPTION CLAUSES

---

- Toshiba Corporation bears no responsibility in the case of damages arising from natural disaster such as earthquakes, lightning, etc., fire not liable to Toshiba Corporation, acts by third parties, other accidents, or use under abnormal conditions including erroneous or improper operation and other problems.
- Toshiba Corporation bears no responsibility for incidental damages (lost profit, work interruption, corruption or loss of the memory contents, etc.) arising from the use of or the inability to use this unit.
- Toshiba Corporation accepts no liability whatsoever for any damages arising from not having followed the descriptions in this Owner's Manual.
- Toshiba Corporation accepts no liability whatsoever for any damages arising from malfunctions arising from combination with equipment or software that is not related to Toshiba Corporation.

# OTHER INFORMATION

## Copyrights

Showing or transmitting commercial imaging software or broadcast or cable-broad casting programs with the purpose of other than the personal and private viewing, including modifying images using the freeze functions, or displaying with the varying aspect ratio of the images, could violate the direct or indirect copyrights of the imaging software or broadcast program, etc., if done without first consulting with the copyright holder. For this reason, take appropriate measures before performing one of the actions listed above, including obtaining a license from the copyright holder.

## Disposal

This product contains substances which are harmful to humans and the environment.

- The lamp contains inorganic mercury.  
Please dispose of this product or used lamps in accordance with local regulations.

### Following information is only for EU-member states:

The use of the symbol indicates that this product may not be treated as household waste. By ensuring this product is disposed of correctly, you will help prevent potential negative consequences for the environment and human health, which could otherwise be caused by inappropriate waste handling of this product. For more detailed information about recycling of this product, please contact your local city office, your household waste disposal service or the shop where you purchased the product.



## Trademarks

- VGA, SVGA, XGA, SXGA, UXGA are trademarks or registered trademarks of International Business Machines Corporation.
- DLP (Digital Light Processing) is a registered trademark of Texas Instruments, Inc.
- Macintosh is a registered trademark of Apple Computer, Inc.
- Windows is a registered trademark of Microsoft Corporation in the U.S. and other countries.
- Adobe and Acrobat Reader are registered trademarks of Adobe Systems Incorporated.
- All other brand and product names are trademarks or registered trademarks of their respective companies.

## Notational Conventions Used in This Manual

- References to pages with related information are annotated as follows.  
For example, if making a reference to page 35: [p.35](#)
- The illustrations in this document are for reference purposes only and may not reflect your package exactly.

# REMOTE CONTROL BATTERY

---

## Warning

- Never throw a battery into a fire.
- Using the battery improperly may cause them to explode or leak and may result in serious injury. If battery-leaking fluid contacts skin, wash the fluid off immediately with clean water and consult a doctor. If the fluid spills on an instrument, avoid contact and wipe it off using tissue paper. Then dispose of the used tissue paper as flammable garbage after moistening it with water.
- Keep the battery away from the reach of children. Battery is choking hazard and can be very dangerous if swallowed. If the battery is swallowed, seek medical assistance immediately.

## Notes

- Be sure to use a CR2025 battery.
- Dispose of a battery in a designated disposal area.
- Check and follow your local regulations before disposal.
- Attention should be drawn to the environmental aspects of battery disposal.
- If the remote control does not operate correctly, or if the operating range becomes reduced, replace the battery with a new one.
- If the battery is dead or if you will not be using the remote control for a long time, remove the battery to prevent battery acid from leaking into the battery compartment.

# CONTENTS

---

## Before Using

SAFETY PRECAUTIONS .....	2
IMPORTANT SAFETY INSTRUCTIONS.....	4
POWER SUPPLY INFORMATION .....	9
IMPORTANT PRECAUTIONS.....	9
EXEMPTION CLAUSES .....	10
OTHER INFORMATION.....	11
REMOTE CONTROL BATTERY .....	12
CONTENTS .....	13

## Preparations

Checking the package contents .....	15
Names of each part on the main unit.....	16
Names of each part on the control panel.....	17
Names of each part on the remote control.....	18
Parts on the rear panel.....	19
Preparing and using the remote control.....	20
Placement .....	21
Connection .....	23

## Operations

Turning the power on and off.....	24
Basic operations.....	26
Using handy features .....	28
Using auto setting (For computer input only).....	28
Correcting the keystone distortion .....	28
Cutting off the picture and sound temporarily (Mute).....	29
Freezing the image (Freeze).....	29
Resizing image .....	30
Using the menus .....	31
How to use the menus .....	31
The image adjustment menu .....	32
The display setting menu .....	33
The default setting menu .....	34
Displaying Information (Status display).....	35

## Maintenance

About lamp .....	36
Lamp replacement .....	37
Lens and main unit cleaning .....	39

## Others

Trouble indications .....	40
Before calling service personnel.....	41

---

Specifications .....	42
List of general specifications .....	42
Separately sold product .....	42
List of supported signals (RGB signals) .....	43
List of supported signals (Component signals) .....	44
List of supported signals (Video, S-Video signals) .....	44
Pin assignment of COMPUTER IN & MONITOR terminals .....	44
CONTROL terminal .....	45

# Checking the package contents

Please make sure that the following items are included in the box, along with the main unit. If any item is missing, immediately contact the store where you purchased the product.

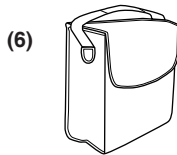
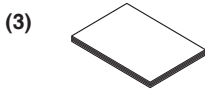
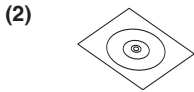
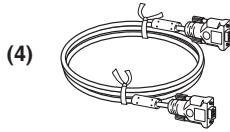
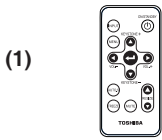

- (1) Remote control
- (2) CD-ROM
- (3) Owner's Manual (This document)
- (4) RGB cable (3m)<sup>(See note below)</sup>
- (5) Power cord <sup>(See note below)</sup>
- (6) Carrying bag

## Note

- The shape and number of supplied power cords vary depending on the product destination.
- To maintain original performance, always use the supplied cables.

## Save Original Packing Materials

The original shipping carton and packing materials will come in handy if you ever have to ship your projector. For maximum protection when shipping your projector, repack the set as it was originally packed at the factory.

### ◆ The Supplied CD-ROM

The supplied CD-ROM contains an owner's manual in Portable Document Format (PDF). Please use Acrobat Reader 5 or later version to view the manual.

#### ■ Adobe® Acrobat® Reader® or Adobe® Reader®

The supplied CD-ROM does not contain Acrobat® Reader®. If you cannot read PDF files, please install Adobe Reader software in your computer by downloading it from the Adobe Systems website.

#### ■ Viewing the manual

Run the CD-ROM and double-click on **Start.pdf**. Acrobat® Reader® launches, and the menu screen of the Owner's manual appears. Click on your language. The Owner's Manual cover and list of bookmarks appear. Click on a bookmark title to view that section of the manual. Click on  to view a reference page with related information. See the Help menu for more information about Acrobat® Reader®.

# Names of each part on the main unit

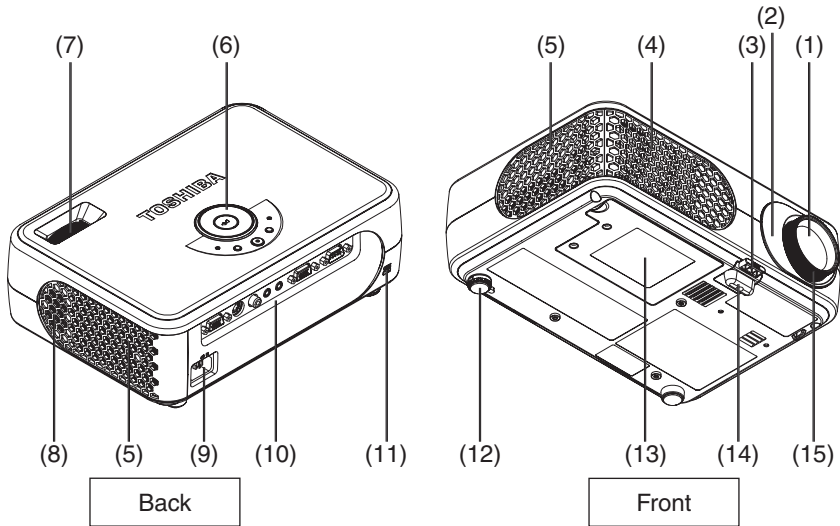

Name	: Function
(1) Lens	: Projects expanded image.
(2) Infrared remote sensor	: Senses commands from the remote control. <a href="#">p.20</a>
(3) Foot adjuster release button	: Press to set up or stow the foot adjuster. <a href="#">p.27</a>
(4) Air exhaust	: Expels air that has grown hot inside the projector.
(5) Air intake	: Draws in air from outside the projector for internal cool down.
(6) Control panel	: Operates the projector. <a href="#">p.17</a>
(7) Zooming ring	: Adjusts screen size. <a href="#">p.27</a>
(8) Speaker	: Outputs audio sound.
(9) AC IN socket	: Connect the supplied power cord here.
(10) Rear panel	: Connects external devices. <a href="#">p.19</a>
(11) Antitheft lock slot	: Attach a safety cable or any other antitheft device.
(12) Tilt adjuster	: Adjusts the projector's horizontal tilt. <a href="#">p.27</a>
(13) Lamp cover	: Remove to replace lamp. <a href="#">p.37</a>
(14) Foot adjuster	: Adjusts the vertical projection angle. <a href="#">p.27</a>
(15) Focusing ring	: Adjusts screen focus. <a href="#">p.27</a>



# Names of each part on the control panel

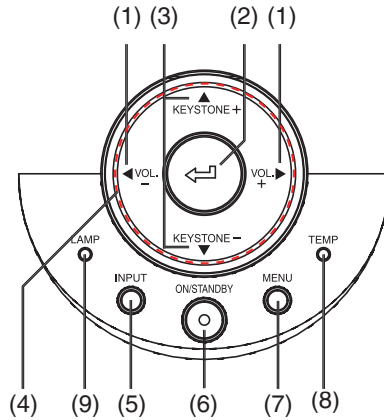

Name : Main Function

## Control panel

- (1) VOL +/- button : Adjusts the volume.
- (2) ENTER button : Accepts the selected mode.
- (3) KEYSTONE +/- button : Adjusts keystone distortion. [p.28](#)
- (4) Selection buttons : Menu selections and adjustments. [p.31](#)
- (5) INPUT button : Selects input source. [p.26](#)
- (6) ON/STANDBY button/indicator : Turns the power on/off (standby). [p.24](#)
- (7) MENU button : Displays power on/off mode. [p.24](#)
- (8) TEMP indicator : Displays menus. [p.31](#)
- (9) LAMP indicator : Lights when internal temperature is too high. [p.40](#)
- (9) LAMP indicator : Displays lamp mode. [p.40](#)

# Names of each part on the remote control

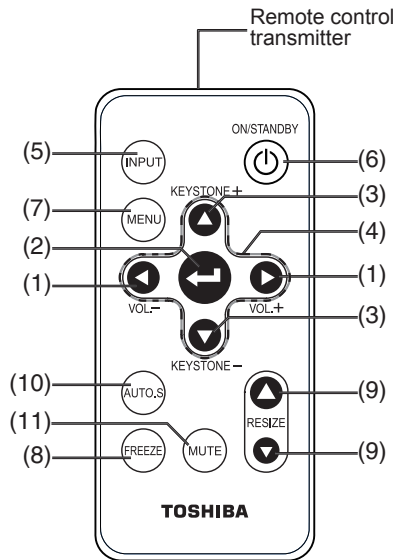

Name	: Main Function
(1) VOL +/- button	: Adjusts the volume.
(2) ENTER button	: Accepts the selected mode.
(3) KEYSTONE +/- button	: Adjusts keystone distortion. <a href="#">p.28</a>
(4) Selection buttons	: Menu selections and adjustments. <a href="#">p.31</a>
(5) INPUT button	: Selects input source. <a href="#">p.26</a>
(6) ON/STANDBY button	: Turns the power on/off (standby). <a href="#">p.24</a>
(7) MENU button	: Displays menus. <a href="#">p.31</a>
(8) FREEZE button	: Pauses image. <a href="#">p.29</a>
(9) RESIZE buttons	: Enlarges images. <a href="#">p.30</a>
(10) Auto-Set button	: Performs auto-adjustment of input signals from computer. <a href="#">p.28</a>
(11) MUTE button	: Cuts off the picture and sound temporarily. <a href="#">p.29</a>

# Parts on the rear panel

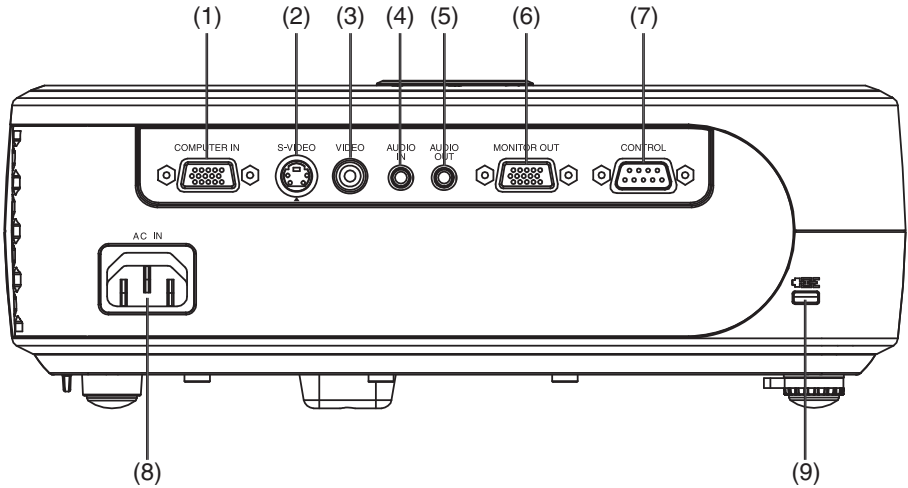

Name	: Main Function
(1) COMPUTER IN terminal	: Input analog RGB signal from a computer or other source, or a component video signal (Y/PB/PR) from video equipment.
(2) S-VIDEO terminal	: Input S video signals from video equipment.
(3) VIDEO terminal	: Input video signals from video equipment.
(4) AUDIO IN terminal	: Input audio signals.
(5) AUDIO OUT terminal	: Outputs audio signals.
(6) MONITOR terminal	: Connect to a computer display, etc.
(7) CONTROL terminal	: When operating the projector via a computer, connect this to the controlling computer's RS-232C port. <a href="#">p.45</a>
(8) AC IN socket	: Connect the supplied power cord here.
(9) Antitheft lock slot	: Attach a safety cable or any other antitheft device.

# Preparing and using the remote control

## ■ Loading a coin cell battery into the remote control

### ① Remove the battery holder.

Hold down the side release firmly and pull out the battery holder.

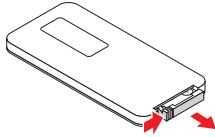

### ② Load a coin cell battery (CR2025).

Be sure to align the plus and minus ends of the battery properly.

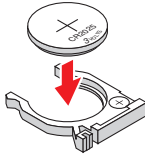

### ③ Replace the battery holder back into the remote control.

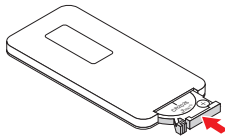

## ■ Coin cell battery

- Before using the battery, be sure to observe the Safety Precautions described in previous pages.
- Remove the battery from remote control when not using for extended periods.
- If the remote control stops working, or if its range decreases, replace the battery with a new one.
- Keep the battery away from the reach of children. Battery is choking hazard and can be very dangerous if swallowed. If the battery is swallowed, seek medical assistance immediately.

## ■ The remote control

- The remote control may fail to operate if the infrared remote sensor is exposed to bright sunlight or fluorescent lighting.
- Do not drop or bang.
- Do not leave in hot or humid locations.
- Do not allow it to get wet or place it on top of wet objects.
- Do not take apart.
- In rare cases, ambient conditions could impede the operation of the remote control. If this happens, point the remote control at the main unit again, and repeat the operation.

## ■ Operating the remote control

Point toward the projector's infrared remote sensor, and press a button on the remote control.

- Operating the projector from the front

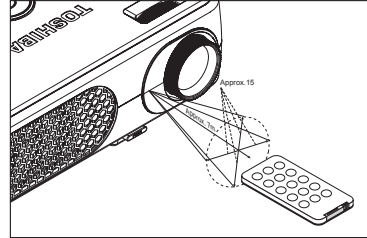

## ■ Notes

- When you use for the first time after purchase, a plastic sheet is provided between the battery and its contact. Be sure to remove by pulling it off.
- When operating the remote control from behind the projector, the infrared beam is reflected on the projecting surface and may travel a shorter distance to reach the projector depending on the shape and material of the projecting surface.

# Placement

## Placement Styles

As shown in the figures below, this device can be placed in 4 different styles. The factory setting is “floor-mounted front projection.” Set the [Projection mode] in the Default setting menu [p.34](#), in accordance with your needs.

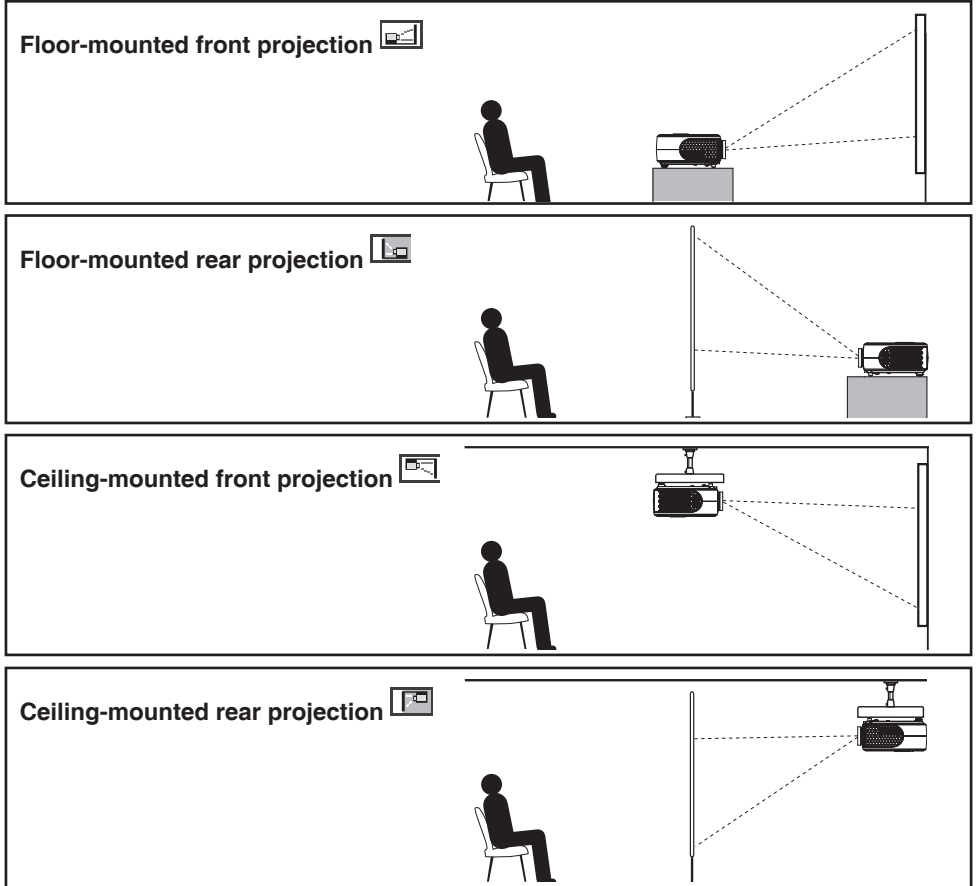

Preparations

### WARNING

- Always obey the instructions listed in **IMPORTANT SAFETY INSTRUCTIONS** when placing the unit. Attempting to clean or replace the lamp in a high location by yourself may cause you to fall, resulting in injury.
- If you wish to mount the projector on the ceiling, be sure to ask your dealer to do so. Mounting the projector on a ceiling requires special ceiling brackets (sold separately) and specialized knowledge. Improper mounting could cause the projector to fall, resulting in an accident.
- If the projector is ceiling-mounted, install the breaker for turning off the power in case of anomaly. Let everyone involved with the use of the projector know that fact.

# Placement (Continued)

## Projection Distance and Size

Use the figures, tables, and formulas below to determine the projection size and projection distance. (Projection sizes are approximate values for full-size picture with no keystone adjustment.)

### As seen from above

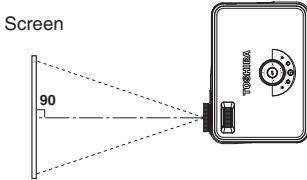

### As seen from the side

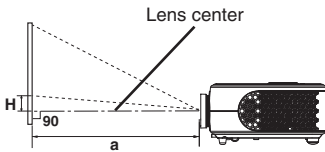

projection size (inches)	Wide		Tele		Offset	
	distance		distance		height (H)	
	(m)	(feet)	(m)	(feet)	(cm)	(feet)
23.9	---	---	1.00	3.28	5.5	0.18
30	1.15	3.77	1.28	4.19	6.9	0.23
40	1.56	5.10	1.73	5.66	9.1	0.30
60	2.37	7.77	2.62	8.60	13.7	0.45
80	3.18	10.43	3.52	11.53	18.3	0.60
100	3.98	13.07	4.41	14.46	22.9	0.75
150	5.99	19.64	6.62	21.72	34.3	1.13
200	7.97	26.15	8.82	28.93	45.7	1.50
250	9.93	32.59	10.99	36.07	57.2	1.88
300	11.88	38.97	---	---	68.6	2.25

**a** is the distance (cm, feet) between the lens and the screen, and corresponds to a range of 1 m to 11.88m (3.28 ft. to 38.97 ft.). **H** is the height (cm, feet) from the image bottom to the center of the lens.

### min length

$$a(\text{cm}) = -0.000381 \times \text{projection size (inches)}^2 + 4.1 \times \text{projection size (inches)} - 7.8$$

$$a(\text{feet}) = -0.000125 \times \text{projection size (inches)}^2 + 0.135 \times \text{projection size (inches)} - 0.256$$

### max length

$$a(\text{cm}) = -0.000365 \times \text{projection size (inches)}^2 + 4.52 \times \text{projection size (inches)} - 7.7$$

$$a(\text{feet}) = -0.00012 \times \text{projection size (inches)}^2 + 0.148 \times \text{projection size (inches)} - 0.253$$

### height

$$H(\text{cm}) = \text{projection size (inches)} \times 0.2286$$

$$H(\text{feet}) = \text{projection size (inches)} \times 0.0075$$

# Connection

## Before connection

- Read the owner's manual of the device you are connecting to the projector.
- Some computers cannot be used with or connected to this projector. Check for an RGB output terminal, supported signal [p.43](#), etc.
- Turn off the power of both devices before connecting.
- The figure below shows sample connections. This does not mean that all of these devices can or must be connected simultaneously.

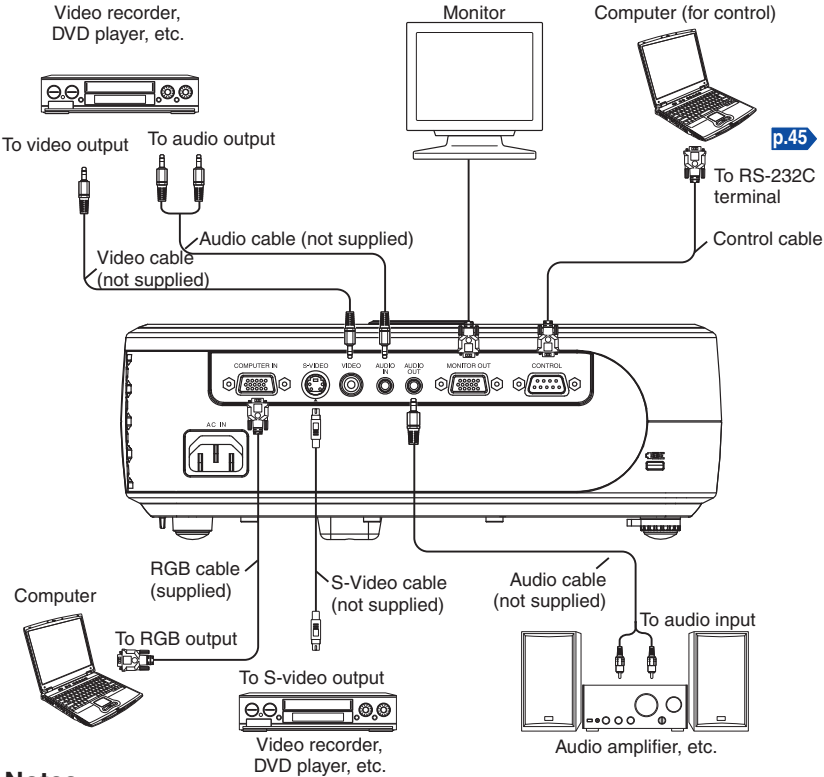

## Notes

- Moving pictures played back on computers using DVD software may appear unnatural when projected with this projector. However, it is not a malfunction of the projector.
- When an AUDIO OUT terminal is connected, sound is not output from the projector speaker.
- Output volume of AUDIO OUT terminal can be adjusted by the **VOL+/-** button.
- The MONITOR OUT terminal outputs analog RGB signals or component video signals (Y/P<sub>B</sub>/P<sub>R</sub>) from the COMPUTER IN terminals.
- A computer monitor usually cannot accept Y/P<sub>B</sub>/P<sub>R</sub> signals correctly.

# Turning the power on and off

## ■ Connecting the power cord

- 1 Insert the power cord connector into the AC IN socket of the projector.
- 2 Insert the power cord plug into a wall or other power outlet.

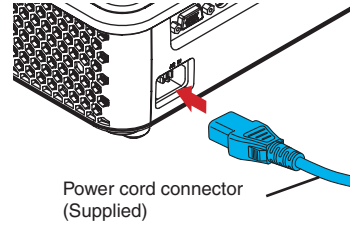

## ■ Removing the lens cover

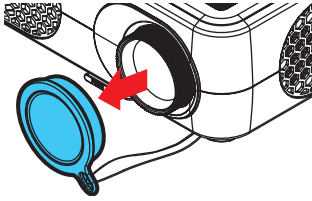

Be sure to remove the lens cover when the power is turned on. If the cover is left on the projector, it could become deformed due to heat.

## ■ Turning the power on

- 1 Press the ON/STANDBY button.

The power is turned on, and the ON/STANDBY indicator lights green. After a moment, the start-up screen appears.

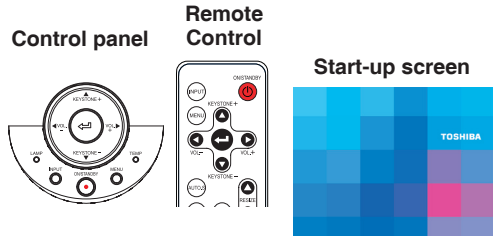

## ⚠ CAUTION

- Do not look into the lens while the lamp is on. The strong light from the lamp may cause damage to your eyesight.
- Do not block the air intake or exhaust. Doing so could cause a fire due to internal overheating.
- Do not place your hands, face, or other objects near the air exhaust, the lamp cover or the bottom of the unit. Doing so could result in injury and/or damage the object.

## ■ Notes

- The start-up screen will disappear after a moment. You can also configure the system to prevent the start-up screen from appearing. To do this, use the **Default setting** menu [p.34](#).
- The first time you use the projector after purchase, after the start-up screen disappears, the start menu is displayed [p.26](#).
- Do not touch the lens directly with your hand. If fingerprints or stains are left on the projection lens surface, they may interfere with the projector's ability to project images on the screen.



## ■ Turning the power off

### 1 Press the ON/STANDBY button.

A message appears on the screen, confirming that you wish to shut off the power. To shut off the power, press the ON/STANDBY button again. If you do not wish to shut off the power, wait for a while without conducting any operations. The message will disappear shortly. (This operation is no longer valid after the message disappears.)

### 2 Press the ON/STANDBY button again.

The screen turns off, but the internal cooling fan continues to operate for a short while. Then, the projector goes into standby mode.

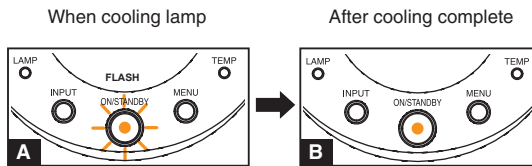

**A** During cooling, the ON/STANDBY indicator flashes. In this state, the power cannot be turned back on.

However, there is no problem with unplugging the power cord in this state.

**B** In standby mode

### ■ Note

- The projector consumes about 6W of power in standby. We recommend that you unplug the power cord if you will not be using the projector for an extended period.

### ■ Precaution

- If the power cord is unplugged before cooling is complete, give the lamp time (about 5 minutes) to cool before plugging it back in. If the lamp overheats, it may fail to light.
- Right after turning off the power, the unit may become very hot, especially air exhaust and the bottom of the unit. Please handle with care to avoid burn injuries.

# Basic operations

---

## 1 Turn on the power.

Turn on the power by following the instructions in “Turning the power on” [p.24](#).

## 2 Select the language (When using the first time).

When the projector is used for the first time after purchase, the start menu for language (to display the menus and messages on screen) and configuration is displayed in English. (if the screen is out of focus, adjust it according to the step 6.)

Use the **▲**, **▼**, **◀** or **▶** button to select the desired language and press the **↻** button.

Message for setup confirmation is displayed in a selected language.

English	English	中文(繁體字)	Traditional Chinese
French	Français	Polski	Polish
German	Deutsch	Bahasa Indonesia	Indonesian
Italian	Italiano	Norsk	Norwegian
Spanish	Español	Suomi	Finnish
Portuguese	Português	Čeština	Czech
Russian	Русский	Magyar	Hungarian
Swedish	Svenska	Ελληνικός	Greek
Turkish	Türkçe	Dansk	Danish
Romanian	Română	Nederlands	Dutch
Simplified Chinese	中文(简体字)		

### Notes

- When the projector is turned on the next time, the start menu does not appear upon startup.
- The language can also be set via the **Default setting** menu [p.34](#).
- This owner's manual assumes that English has been selected.

## 3 Activate the connected device.

Turn on and start the connected device such as a computer.

## 4 Press the INPUT button.

An image of the connected equipment is projected.

Each time you press the **INPUT** button, it switches to another source signal from the equipment which is connected to the projector.

### Notes

- When [**Auto input search**] is set to [**On**] in the **Default setting** menu [p.34](#) (factory setting is [**On**]), the input is switched to the connected equipment that is outputting video signals each time you press the **INPUT** button [p.43](#).
- Right after the input source is switched to the other, the color of the image may change slightly.

## 5 Projector placement angle adjustments

The placement angle and the height of the projected image can be adjusted by the foot adjuster.

- 1 **Lift up the front of the projector to the desired angle, then press the foot adjuster release button.**  
The foot adjuster extends. Release the button to lock the position.
- 2 **To adjust the horizontal angle, use the tilt adjuster.**

To stow the foot adjuster, hold up the projector while pressing the foot adjuster release button, then slowly lower the projector.

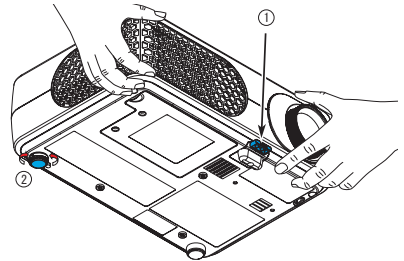

## 6 Adjusting the screen size and focus

- 1 **Use the zooming ring to adjust the screen size.**
- 2 **Use the focusing ring to adjust the focus.**

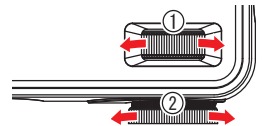

## 7 Adjusting the volume with VOL+/- buttons

The speaker volume can be adjusted when an audio signal is being input.

### Notes

- Lamp characteristics may rarely cause the brightness to fluctuate slightly.
- A lamp is consumable item. If used for extended periods, images will appear dark, and the lamp could burn out. This is characteristic of a lamp, and is not malfunction. (The lifetime of the lamp depends on conditions of use.)
- The DLP® chip is made using extremely advanced technology. There may be black spots (pixels that do not light) or bright spots (pixels that are constantly lit) on the panel. These are intrinsic characteristics of the technology and are not malfunctions.
- Although this projector supports a wide range of RGB signals [p.43](#), any resolutions not supported by this projector (XGA) will be expanded or shrunk, which will affect image quality slightly. To view high-quality images, set the computer's external output to XGA.
- With some models of computer having LCD displays or the like, displaying images simultaneously on the projector and the monitor's display may prevent the images from displaying properly. If this happens, turn off the computer's LCD display. For information on how to turn off the LCD display, see the computer's owner's manual.
- If no signal is being input from the connected equipment or signal input is stopped while projecting, the **"No signal"** message will appear.
- If a signal not supported by the projector is input, the **"Unsupported signal"** message will appear.
- If an unavailable operation button is pressed, the  icon will appear.

# Using handy features

## ■ Using auto setting (For computer input only)

This function automatically sets up the projector to the optimum state. It sets up sampling phase, frequency and screen position for each type of the input signal by using simple operations.

### ● Press the remote control's AUTO SET button.

The  icon will appear during processing.

### ■ Notes

- The image may not be projected or auto adjustment/setting may not be performed correctly for input signals other than those supported by the projector [p.43](#), [p.44](#).
- If auto setting fails adjustment, adjust manually with **Image adjustment** menu [p.32](#).

### Remote Control

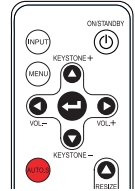

## ■ Correcting the keystone distortion

When the projector placement angle against the screen is changed while projecting the image, the picture will undergo keystone (trapezoidal) distortion.

This projector is capable of correcting this keystone distortion.

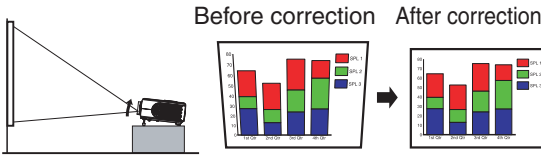

### ● Press the KEYSTONE +/- button.

You can also select **[Keystone]** in the **Image adjustment** menu [p.32](#).

### ■ Notes

- Depending on the amount of keystone adjustment and the content of images, some information may be lost, or the picture quality may suffer.

### Control panel

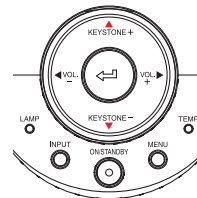

### Remote Control

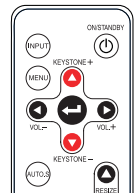

## ■ Cutting off the picture and sound temporarily (Mute)

When you want to project the images of another projector, overhead projector, etc. temporarily, this projector's images and sound can be turned off.

### ● Press the remote control's MUTE button.

The picture and sound are cut off. (The Mute function is released when pressing the **MUTE** button again.)

### ■ Notes

- The  icon will appear while mute is in effect.
- Operating any other functions will also cancel the muting.

Remote Control

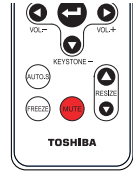

## ■ Freezing the image (Freeze)

The projected image can be frozen. This function is used to pause a video during a presentation, etc.

### ● Press the remote control's FREEZE button.

The picture pauses. (The Freeze function is released by pressing the **FREEZE** button again.)

### ■ Notes

- The  icon will appear while freeze is in effect.
- Other operations will also release the freeze.
- Although an image is frozen on the projector, the pictures are running on the video or other equipment.
- If you use this function on commercial video software, broadcast or cable-broadcasting except for the purpose of your private viewing and listening, it may infringe the copyright protected by the copyright laws.

Remote Control

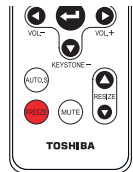

# Using handy features (Continued)

## ■ Resizing image

The projected image can be resized (zoomed in/out).

### 1 Press the remote control's RESIZE ▲ button.

Each time you press the RESIZE ▲ button, zoom ratio is up. You can keep pressing.



### 2 To zoom out, press the remote control's RESIZE ▼ button.

Each time you press the RESIZE ▼ button, zoom ratio is down. You can keep pressing. (However, the image cannot be smaller than the original size.)

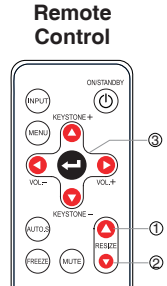

### 3 To move the area to zoom in, use the ▼ ◀ ▶ ▲ buttons.

You can keep pressing.



### 4 When the image returns to the original size by pressing RESIZE ▼ button several times, the zoom will be reset.

## ■ Notes

- The  icon appears while resizing.
- Operating a function other than Mute will release resizing.
- As zooming is processed digitally, the image quality is degraded in larger zoom ratio.
- During resizing or moving the zooming area, the image may be distorted.

# Using the menus

You can call up on-screen menus, and conduct a number of adjustments and settings using the operation buttons [p.18](#) on the control panel (main unit side) and remote control.

## ■ How to use the menus

The menu shown below is for operation instructions purposes and might differ from the actual display.

**1. Press the MENU button** Display the **Setting display** menu.

**2. Select a Category**

Select a category by using .

There are following 4 categories:

- Image adjustment menu** [p.32](#)
- Display setting menu** [p.33](#)
- Default setting menu** [p.34](#)
- Status display menu** [p.35](#)

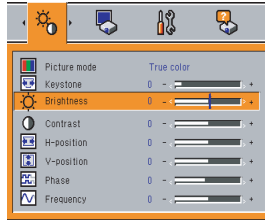

Displays the current adjustments and settings of selected category. Item shown with gray cannot be adjusted with the current input source.

**3. Adjustments & Settings** Press the or button.

Item

Adjustment/Setting Value

These marks signify the items can be adjusted/set by using .

These marks signify the items can be selected from the list by using .

After an item is selected, apply it by pressing .

The figure shows displays given for operation instructions purposes. As the display may differ depending on the item, use the information in this manual as a reference.



































**4. Back MENU button**

**5. End Press the MENU button**  
The menu disappears.

## Using the menu (Continued)

### ■ The image adjustment menu

Use this menu to set or adjust image-related items. Items that can be set or adjusted are marked “Yes”, and those that cannot are marked “No”. (When an item is masked, it indicates that you cannot select for the current input.)

Item  	Description	RGB	Y/P <sub>B</sub> /P <sub>R</sub>	Video	S-video
 <b>Picture mode</b>	Toggle the picture mode with  /  Bright/Standard/True color(RGB) Standard/Cinema(Y/P <sub>B</sub> /P <sub>R</sub> , Video, S-video)	Yes	Yes	Yes	Yes
 <b>Keystone</b>	Correct the keystone (trapezoid) distortion of the screen. Screen shrinking   Screen shrinking at bottom at top	Yes	Yes	Yes	Yes
 <b>Brightness</b>	Adjust the brightness of the image. Darker   Brighter	Yes	Yes	Yes	Yes
 <b>Contrast</b>	Adjust the image contrast. Lower   Higher	Yes	Yes	Yes	Yes
 <b>Color</b>	Adjust the color of the image. Lighter   Deeper	No	Yes	Yes	Yes
 <b>Tint</b> *1	Adjust the tint of the image color. Reddish   Greenish	No	No	Yes	Yes
 <b>Sharpness</b>	Adjust the sharpness of the image. Softer   Sharper	No	Yes	Yes	Yes
 <b>H-position</b>	Adjust the horizontal position of the image. Move left   Move right	Yes	No	No	No
 <b>V-position</b>	Adjust the vertical position of the image. Move down   Move up	Yes	No	No	No
 <b>Phase</b>	Adjust with   to eliminate flicker.	Yes	No	No	No
 <b>Frequency</b>	Adjust with   to eliminate periodic patterns and flickering when fine vertical lines appear on the screen.	Yes	No	No	No













\*1: [TINT] can be displayed and adjusted only when the video signal is set to [NTSC] and [NTSC4.43].



## ■ The display setting menu

Use this menu to set screen display-related items.

(The items in gray color cannot be set with the current input selection.)

Item ▲ ▼	Description
 <b>Screen size</b>	Screen size setting.   (Full): Display with 1024 × 768 dot resolution  (Wide): Wide-screen display  (Thru): Display with sampling resolution
 <b>Up/down shift</b>	Adjust the vertical position of 16:9 image <span style="float: right;">Lower ◀ ▶ Higher</span>
 <b>Back-ground</b>	Screen to display when there is no input signal (Logo)  ◀ ▶  (Blue) ◀ ▶  (Black)
 <b>Icon</b>	Display icons as function guides <span style="float: right;">On ◀ ▶ Off</span>
 <b>Reset all</b>	Press  . Resets all adjustments and settings to their factory settings. <span style="float: right;">Yes ◀ ▶ No</span>

### ● Detailed description

#### [Screen size]

- If “Thru” is selected for [Screen size], portions exceeding the native resolution (1024 × 768 pixels) will not appear on the screen. Note that for RGB signals with clock frequency 110MHz or lower, all input pixel signals are properly sampled. However, if the clock speed is higher than this, the RGB pixel signal is thinned before sampling.
- If you use the screen size setting function on commercial video software, broadcast or cable-broadcasting programs to display images with the varying aspect ratio except for the purpose of your private viewing and listening, it may infringe the copyright protected by the copyright laws.















#### [Background]

- TOSHIBA is set for [Logo] by factory setting.

# Using the menu (Continued)

## ■ The default setting menu

This menu shows placement status and other settings.

Item ▲ ▼	Description
 <b>Projection mode</b>	Sets projection mode in accordance with Placement Style. <a href="#">p.21</a>  (Standard) ◀ ▶  (Rear) ◀ ▶  (Ceiling) ◀ ▶  (Rear ceiling)
 <b>Auto input search</b>	Sets whether the input source with signals is only selected or not. <b>On</b> ◀ ▶ <b>Off</b>
 <b>Language</b>	Select one of the languages below to use for displaying the menu and messages [  : Enter setting mode ] → [  : Selection ] → [ Apply:  ] <b>English/Français/Deutsch/Italiano/Español/Português/Русский/Svenska/Türkçe/Română/中文(簡体字)/中文(繁体字)/Polski/Bahasa Indonesia/Norsk/Suomi/Čeština/Magyar/Ελληνικά/Dansk/Nederlands</b>
 <b>Start-up screen</b>	Sets whether the start-up screen displays when power is turned on. <b>On</b> ◀ ▶ <b>Off</b>
 <b>Fan mode</b>	Sets the cooling fan speed. <b>Standard</b> ◀ ▶ <b>High</b>
 <b>Lamp power</b>	Sets the lamp power. <b>Standard</b> ◀ ▶ <b>Low</b>
 <b>Power on</b>	Sets whether to turn on the power when the <b>ON/STANDBY</b> button is pressed (Manual), or when the power cord is plugged in (Auto). <b>Manual</b> ◀ ▶ <b>Auto.</b>

### ● Detailed description

#### [Auto input search]

Automatically searches the input source that can be projected, and switches source from the connected device each time the **INPUT** button is pressed. If the connected device outputs no source signal, the input is skipped. When the source signal is stopped during projecting, it will switch to the other inputs automatically. If no input sources are detected, it will stop searching and “**No signal**” message will appear.

#### [Fan mode]

Setting [Fan mode] to [High] increases the cooling fan speed. (The cooling fan noise gets louder.) Set this option to use the projector, for example, at high altitude (over 1,500m or 5000 ft. above sea level).

#### [Lamp power]

When [Lamp power] is set to [Low], the screen becomes a little darker, but the cooling fan noise gets quieter.

#### [Power on]

If [Power on] is set to [Auto] and there is a power outage, the projector will come on once power is restored.

## ■ Displaying Information (Status display)

This displays information about the input signal, lamp use time, etc.

“Yes”: displayed, “No”: not displayed

Item	Description	Computer	Y/P <sub>B</sub> /P <sub>R</sub>	Video	S-video
Input	Input source name	Yes	Yes	Yes	Yes
Resolution	Resolution (in dots) <sup>[Note 1]</sup>	Yes	No	No	No
Video mode	Color method of video signal	No	Yes	Yes	Yes
Picture mode	Picture mode setting	Yes	Yes	Yes	Yes
Lamp time	Time of lamp use <sup>[Note 2]</sup>	Yes	Yes	Yes	Yes
Version	Firmware version <sup>[Note 3]</sup>	Yes	Yes	Yes	Yes

### Notes

- 1: The Resolution of supported RGB signals [p.43](#) is shown.
- 2: Displays [**Lamp time**] as a measure of when the lamp should be replaced. (Cannot be used as a counter of guaranteed lamp time.) When the displayed time approaches 3,000 hours, consult with a dealer about getting a TLPLV10 replacement lamp (sold separately) prepared.
- 3: [**Version**] shows the version of the projector's internal control program. This firmware version will be requested for customer service purposes.

### ■ Note

- The displayed information will not be refreshed if the status changes. To refresh the information, dismiss the display, then display it again.

# About lamp

---

The product's light source is a mercury lamp that lights at increased internal pressure. Be sure to fully understand the following characteristics of the lamp and handle it with extreme care.

- The lamp may burst with a loud noise due to impact or deterioration, or fail to light at the expiration of its life.
- How long it takes before the lamp bursts or the life expires may vary greatly by lamp. Some may burst shortly after first use.
- Burst is likely to happen if the lamp is used after the replacement period has elapsed.
- When the lamp bursts, the broken pieces of glass may get inside the product or be released outside from the openings for ventilation.
- When the lamp bursts, a slight amount of mercury gas enclosed in the lamp along with glass dust may be released from the openings for ventilation.

## ■ Immediately replace the lamp when a replacement message appears on the screen.

- When the replacement time approaches, a message will appear on the screen.
- The risk of burst will increase if the lamp is continuously used without being replaced.
- Frequently check the used hours and prepare spares when the replacement time approaches. (Refer to “**Status display**”. [p.35](#))

## ■ When the lamp is broken

- If glass components, including a lamp and a lens, should break, handle the broken pieces with care to avoid injury and contact your dealer for repair service.
- In the event of lamp burst, unplug the product from the wall outlet, leave and completely ventilate the room. Then, thoroughly clean the area around the projector and discard any edible items placed in that area, as they may be contaminated.
- When the lamp bursts, consult a doctor if glass dust or mercury gas gets into your eyes or is inhaled.

# Lamp replacement

A lamp is consumable supply. If used for extended periods, images will appear dark, and the lamp could burn out. This is characteristic of a lamp, and is not malfunction. (The lifetime of the lamp depends on condition of use.) If this happens, replace it with a new one.

## WARNING

- If the projector is mounted on the ceiling, it is recommended to use your Toshiba dealership when the lamp has to be exchanged.

Uncovering the lamp while the projector is mounted on a ceiling may lead to a danger of damage from falling pieces of glass if the lamp is broken. Besides, working at high elevations can also be hazardous. Do not attempt to replace the lamp by yourself.

- When replacing, always use lamp “TLPLV10” (sold separately). If the lamp other than the specified one is used, it may cause a malfunction or damage to the unit due to the difference in the connector shape or the lamp rate.

## CAUTION

- If you have been using the projector, the lamp will be very hot, and may cause burn injuries.

Wait for the lamp to cool (for longer than 1 hour) before replacing it.

- If the lamp should break, please handle with care to avoid injury due to broken pieces and contact your dealer for repair service.

## **1** Unplug power cord.

## **2** Wait until lamp is sufficiently cooled.

Wait for at least 1 hour.

## **3** Remove the lamp cover.

Loosen the two screws, raise the lamp cover with your fingers as shown to remove the lamp cover. Use care to avoid any damage to nails and/or tip of your finger(s). If you have any difficulty in removal, you can use a screwdriver or any other smaller tool for your convenience.

## **4** Pull out the lamp.

Loosen the two screws holding the lamp in place, and pull up the handle to remove the lamp.

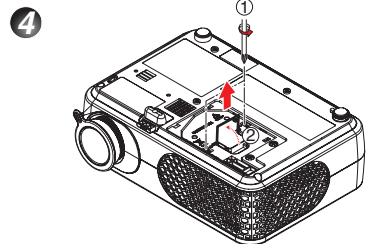
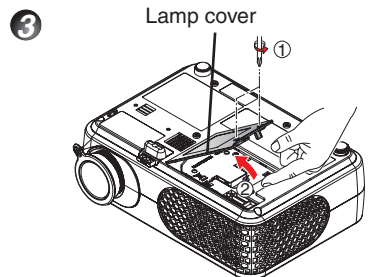

## Lamp replacement (Continued)

---

### 5 Mount the new lamp.

Align the orientation, press down the new lamp until the bottom is reached, and lock in place using the two lamp locking screws.

5

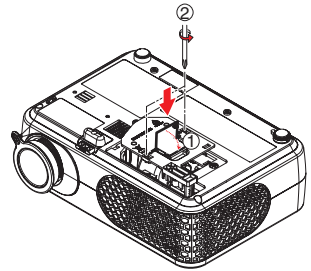

### 6 Replace the lamp cover.

Align the cover, and press it in, then tighten the screws loosened in step 4 until the lamp cover is no longer loose. (Be sure to replace the lamp cover.)

### 7 Reset the lamp time.

See the lamp's manual for instructions on resetting the lamp time.

## Notes and Precautions

- The [**Lamp time**] item in the **Status display** menu indicates the time of lamp use (as a rough guide). [p.35](#)
- It is recommended that the lamp be replaced after 3,000 hours of use. When [**Lamp time**] reaches 3,000 hours, a message will appear. (After 3,000 hours, the message will appear when the power is first turned on after each 100 hour period of use.) This display disappears when you press the button.
- Attach the lamp cover correctly so that it is not loose. If it is not attached correctly, the projector may fail to be powered on or the lamp may fail to come on.
- Always replace the lamp with a new one.
- The lamp is made out of glass. Do not touch the glass surface with your bare hands, bang it, or scratch it. (Dirt, jolts, scratches and the like could break the lamp.)

## Used Lamps

This projector's lamps contain trace amounts of environmentally harmful inorganic mercury. Be careful not to break used lamps, and dispose of them in accordance with local regulations.

# Lens and main unit cleaning

## WARNING

- Request cleaning and maintenance of a ceiling-mounted unit from your projector dealership.  
Attempting to clean or replace the lamp in a high location by yourself may cause you to fall, resulting in injury.

## ■ Lens cleaning

- Clean the lens with a commercially available blower and/or lens cleaner.
- The lens is easily scratched, so do not rub it with hard objects, or strike it.

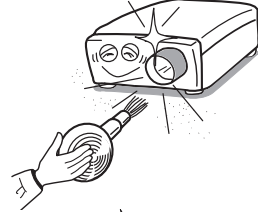





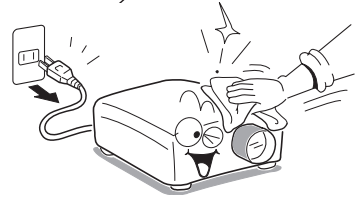

## ■ Main unit cleaning

- Unplug the power cord before cleaning the main unit.
- Wipe dirt off the main unit gently with a soft cloth.
- Do not wipe the main unit with a damp cloth. Doing so may allow water to get inside, resulting in an electric shock or unit failure.
- Do not use benzene, thinner and the like as they may deform or discolor the unit or damage the paint surface.
- Do not use a chemically saturated cloth.

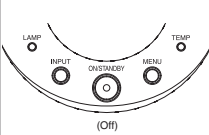
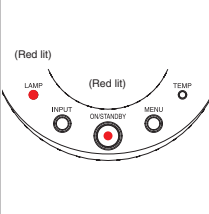
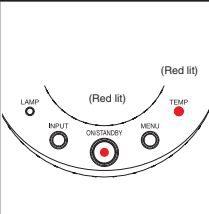

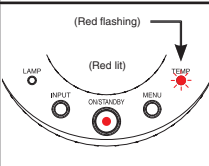
# Trouble indications

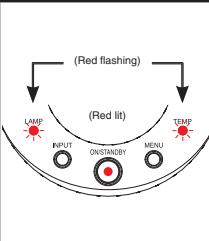
The indicator lights to inform you of interterminal abnormalities.

	<p><b>No power</b></p> <p>⇒ <b>Problem with projector</b></p> <ul style="list-style-type: none"> <li>• Unplug the power cord, and contact your dealer.</li> </ul>
	<p><b>Lamp went out during use, or won't come on</b></p> <p>⇒ Lamp temperature is high so that it is difficult to turn on, the lifetime of the lamp has ended or the projector is malfunctioning.</p> <ul style="list-style-type: none"> <li>• Unplug the power cord and wait for a short while, then turn the power back on.</li> <li>• If a lamp burns out, replace it with a new one.</li> </ul> <p>* After approx. 5 second of abnormal display, the projector returns to the standby state waiting for internal cool down.</p>
	<p><b>Power went out during use</b></p> <p>⇒ Internal overheating, or the outside temperature is too high.</p> <ul style="list-style-type: none"> <li>• Place the projector so that the air intake and exhaust are not blocked.</li> <li>• Unplug the power cord and wait for a short while, then turn the power back on.</li> </ul> <p>* The  icon will appear before the power goes out.</p> <p>* After approx. 5 second of abnormal display, the projector returns to the standby state waiting for internal cool down.</p>
	<p><b>Power went out during use</b></p> <p>⇒ Problem with internal cooling fan.</p> <ul style="list-style-type: none"> <li>• Unplug the power cord, and contact your dealer.</li> </ul> <p>* The  icon will appear before the power goes out.</p> <p>* After approx. 5 second of abnormal display, the projector returns to the standby state waiting for internal cool down.</p>
	<p><b>Power went out during use</b></p> <p>⇒ Problem inside the projector.</p> <ul style="list-style-type: none"> <li>• Unplug the power cord and wait for a short while, then turn the power back on.</li> <li>• If the above action will not clear the problem, unplug the power cord, and contact your dealer.</li> </ul> <p>* The  icon will appear before the power goes out.</p> <p>* After approx. 5 second of abnormal display, the projector returns to the standby state waiting for internal cool down.</p>



# Before calling service personnel

If you think something is wrong, check the followings before contacting customer service. Please see “**Trouble indications**” [p.40](#) as well.

If This Happens	Check
<b>No power</b>	<ul style="list-style-type: none"> <li>• Is the power cord plugged in? Is it connected to the projector?</li> <li>• Is the lamp cover attached properly? <a href="#">p.37</a></li> </ul>
<b>Power goes out during use</b>	<ul style="list-style-type: none"> <li>• Is the ambient temperature high? <a href="#">p.40</a></li> <li>• Is the air intake or air exhaust blocked? <a href="#">p.40</a></li> </ul>
<b>No picture</b>	<ul style="list-style-type: none"> <li>• Is the input source selected correctly? (When [Auto input search] is [Off]) <a href="#">p.26</a></li> <li>• Is the mute function on? <a href="#">p.29</a></li> <li>• Is the brightness setting minimized? <a href="#">p.32</a></li> <li>• Are the connections set up correctly? <a href="#">p.23</a></li> <li>• Are all the connected devices functioning properly?</li> </ul>
<b>No audio</b>	<ul style="list-style-type: none"> <li>• Is the mute function on? <a href="#">p.29</a></li> <li>• Is the volume setting minimized? <a href="#">p.27</a></li> <li>• Are the connections set up correctly? <a href="#">p.23</a></li> <li>• Are all the connected devices functioning properly?</li> </ul>
<b>Picture not displayed correctly</b>	<ul style="list-style-type: none"> <li>• Is the input signal supported by the projector? <a href="#">p.43</a> , <a href="#">p.44</a></li> <li>• Is there something generating an abnormal video signal, for instance the video tape?</li> </ul>
<b>Picture blurred Part of picture out of focus</b>	<ul style="list-style-type: none"> <li>• Is the lens dirty? <a href="#">p.39</a></li> <li>• Is the lens focus adjusted optimally? <a href="#">p.27</a></li> <li>• Is the projection distance within the projector's supported range? <a href="#">p.22</a></li> <li>• Is the projector's screen placement angle tilted too far? <a href="#">p.22</a></li> <li>• Are the sharpness or sampling phase adjustments off?</li> </ul>
<b>Image is dark</b>	<ul style="list-style-type: none"> <li>• Are the brightness or contrast adjustments off? <a href="#">p.32</a></li> <li>• Is the lamp nearing the end of its service life? <a href="#">p.35</a></li> </ul>
<b>Colors too light Bad shading</b>	<ul style="list-style-type: none"> <li>• Are the color, tint adjustments off? <a href="#">p.32</a></li> <li>• Is the screen dirty?</li> <li>• Is the lamp nearing the end of its service life? <a href="#">p.35</a></li> </ul>
<b>Remote control doesn't work</b>	<ul style="list-style-type: none"> <li>• Is the remote control's battery drained?</li> <li>• Is the battery inserted into the remote control correctly? <a href="#">p.20</a></li> <li>• Is the remote control being used within the effective range? <a href="#">p.20</a></li> <li>• Are there any obstructions between the remote control and projector?</li> <li>• Are there any fluorescent or other bright lights shining at the projector's infrared remote sensor?</li> </ul>

# Specifications

## ■ List of general specifications

Item	Specification	
Consumption Power	280 W	
Weight	2.2 kg	
External Dimensions (including protruding parts)	270 x 98 x 198 mm (W x H x D)	
Cabinet material	PC resin	
Conditions for usage environment	Temp: 5°C to 35°C; relative humidity: 80%	
Display pixels	1 DLP® chip	
Picture elements	786,432 pixels (1024H × 768V)	
Lens	Zoom lens F=2.4-2.6 f=21.81-23.77 mm	
Lamp	High-pressure mercury lamp (200 W)	
Projection screen size	23.9-300 inches	
Projection distance	1.0m - 11m	
Speaker	2 W	
Connection terminal	CONTROL terminal	RS-232C: D-Sub 9 pin
	COMPUTER(Y/PB/PR) IN terminal	Mini D sub 15 pin Analog RGB / Y/PB/PR (dual use)
	VIDEO terminal	S-VIDEO: Mini DIN 4 pin
		VIDEO: RCA Pin Jack
		AUDIO: 3.5mm dia. stereo mini-jack
	MONITOR terminal	Mini D sub 15 pin RGB / Y/PB/PR (dual use)
AUDIO OUT terminal	3.5mm dia. stereo mini-jack	

## ■ Notes

- This model complies with the above specifications.
- Designs and specifications are subject to change without notice.
- This model may not be compatible with features and/or specifications that may be added in the future.

## ■ Separately sold product

Replacement Lamp      Model: TLPLV10

## ■ List of supported signals (RGB signals)

This projector supports the following RGB signals. Note, however, that depending on the computer model, the screen may show flicker or streaking. Please adjust the projector if this happens.

Resolution	Mode	Refresh rate [Hz]	H-frequency [KHz]	Clock (MHz)
640x480	VGA_60	59.94	31.46	25.17
	VGA_72	72.8	37.86	31.5
	VGA_75	75	37.5	31.5
	VGA_85	85	43.26	36
720x400	720x400_70	70	31.5	32
	720x400_85	85.03	37.92	35.5
800x600	SVGA_56	56.25	35.15	36
	SVGA_60	60.3	37.87	40
	SVGA_72	72.18	48.07	50
	SVGA_75	75	46.87	49.5
	SVGA_85	85.06	53.67	56.25
1024x768	XGA_60	60	48.36	65
	XGA_70	70.06	56.47	75
	XGA_75	75.02	60.02	78.75
	XGA_85	84.99	68.67	94.5
1280x1024	1280x1024_60	60.02	63.98	108
1152x864	1152x864_70	70	63.85	90.3
	1152x864_75	75	67.5	108
1280x960	1280x960_60	60	60	108
832x624	MAC 16"	74.55	49.725	57.28
1024x768	MAC 19"	75	60.24	79.85
1152x870	MAC	75.06	68.68	81
640x480	MAC G4	60	31.35	40
1024x768	i Mac DV	75	60	79
1152x870	i Mac DV	75	68.49	80.05

### ■ Note

- Signals of which resolution exceeds the native resolution (1024 × 768 pixels) will be compressed. For this reason, some information may be lost, or image quality may be affected.

# Specifications (Continued)

## List of supported signals (Component signals)

Signal format	fh(kHz)	fv(Hz)
480i (525i) @60Hz	15.73	59.94
480p (525p) @60Hz	31.47	59.94
576i (625i) @50Hz	15.63	50.00
576p (625p) @50Hz	31.25	50.00
720p (750p) @60Hz	45.00	60.00
720p (750p) @50Hz	37.50	50.00
1080i (1125i) @60Hz	33.75	60.00
1080i (1125i) @50Hz	28.13	50.00

## List of supported signals (Video, S-Video signals)

Video mode	fh(kHz)	fv(Hz)	fsc(MHz)
NTSC	15.73	60	3.58
PAL	15.63	50	4.43
SECAM	15.63	50	4.25 or 4.41
PAL-M	15.73	60	3.58
PAL-N	15.63	50	3.58
PAL-60	15.73	60	4.43
NTSC4.43	15.73	60	4.43

## Pin assignment of COMPUTER IN & MONITOR terminals

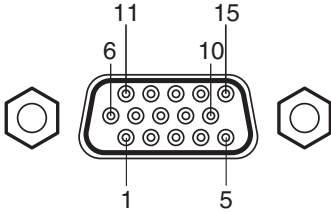

Mini D sub 15 Pin connector

### Input Signal

- RGB input  
 RGB signals: 0.7V (p-p) 75 Ω  
 Horizontal sync signal: TTL level (Pos/neg polarity)  
 Vertical sync signal: TTL level (Pos/neg polarity)
- Y/P<sub>B</sub>/P<sub>R</sub> input  
 Y signal: 1.0V (p-p) 75 Ω  
 P<sub>B</sub>/P<sub>R</sub> signals: 0.7V (p-p) 75 Ω

Pin No.	Pin description	
	During RGB input	During Y/P <sub>B</sub> /P <sub>R</sub> input
1	Video signal (R)	Color difference signal (P <sub>R</sub> )
2	Video signal (G)	Luminance signal (Y)
3	Video signal (B)	Color difference signal (P <sub>B</sub> )
4	N.C	*
5	GND	*
6	GND (R)	GND (P <sub>R</sub> )
7	GND (G)	GND (Y)
8	GND (B)	GND (P <sub>B</sub> )
9	+5V	*
10	GND	*
11	N.C	*
12	SDA	*
13	Horizontal sync signal	*
14	Vertical sync signal	*
15	SCL	*

\* Do not connect anything.

## ■ CONTROL terminal

### ● Pin assignment

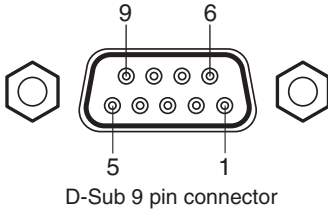

Pin No.	Signal Name	Description
1	N.C	*
2	TXD	Sending data
3	RXD	Receiving data
4	N.C	*
5	GND	Signal ground
6	N.C	*
7	N.C	*
8	N.C	*
9	N.C	*

\* Do not connect anything.

### ■ Notes

- Contact your dealer for control cable and commands.

**TOSHIBA CORPORATION**

# TOSHIBA

Leading Innovation >>>

## TDP-XP1

### DATA PROJECTOR

---

### OWNER'S MANUAL



In the spaces provided below, record the Model and Serial No. located at the bottom of your projector.

Model No. \_\_\_\_\_ Serial No. \_\_\_\_\_

Retain this information for future reference.

English

Français

Español

Deutsch

**TOSHIBA CORPORATION**